



INSTALL

SolidPool install manual

INSTALL

CONCRETE SLAB

The SolidPool structure must be installed on a reinforced concrete slab.

It is the installer's responsibility to ensure that the slab is poured on a solid base according to site conditions.

Recommended minimum slab thickness: **6 inches**

The slab must extend a minimum of 12" beyond the inside measurements of the structure. Therefore 6" all around the outside wall measurements.

Don't forget to install the bottom drains

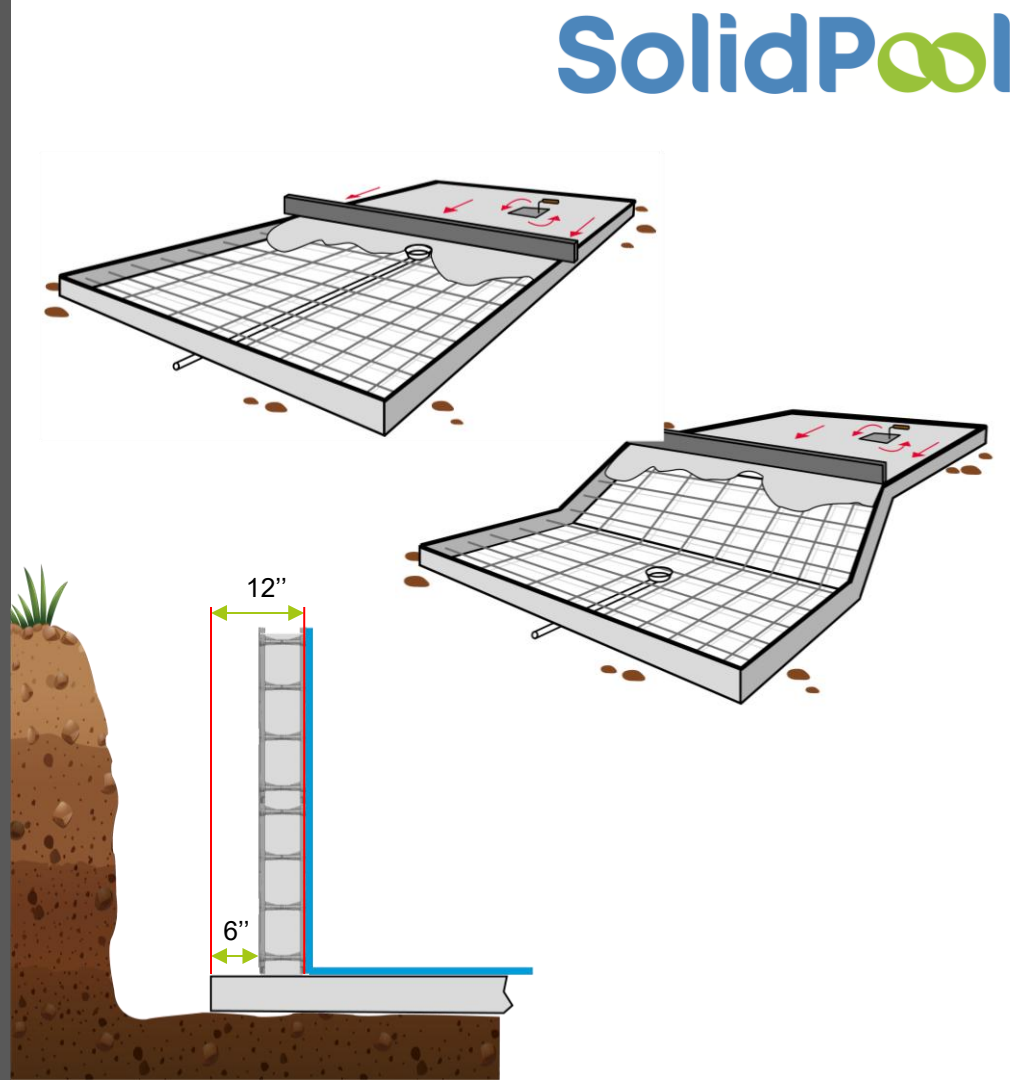



INSTALL

MARK THE POOL ON YOUR SLAB

Lay out and trace the inside of the pool on the slab.

The diagonal measurements are indicated on the technical drawing.

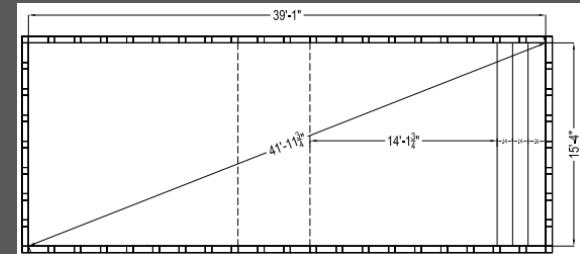
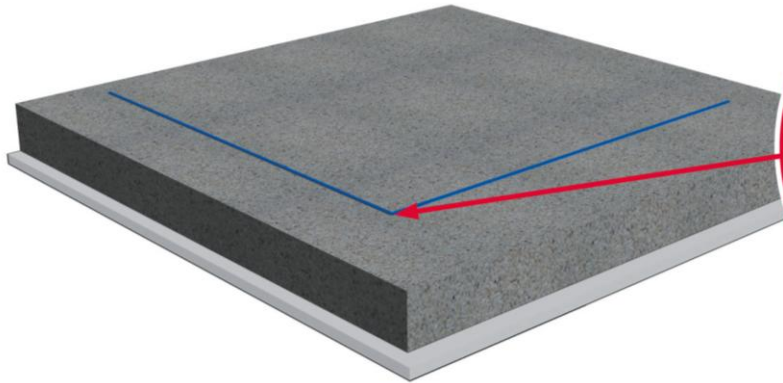

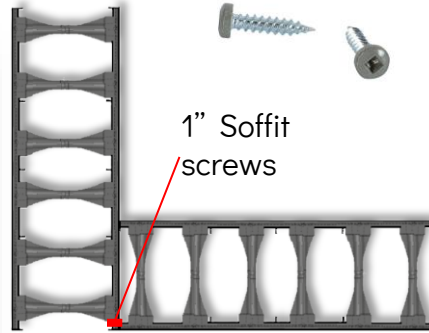

INSTALL

INSTALLING THE CORNER BLOCKS

Screw the two corner blocks together at the top and bottom. (For an above-ground installation, insert the horizontal corner rod from the middle of the block BEFORE screwing in the corner).

Be careful not to screw the screws too close to the top of the block. This could interfere with the insertion of the next row.

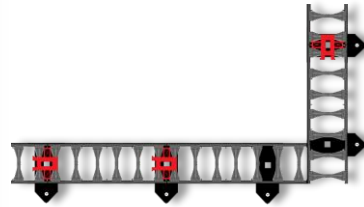

Install the soles under the blocks.

One sole at each block joint and as close as possible to both sides of each corner.

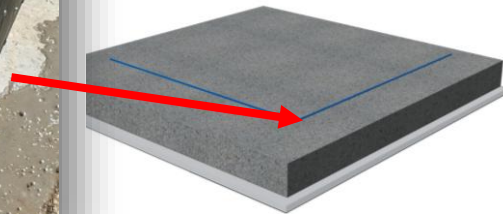

Place the corner blocks along the lines marked on the slab.

INSTALL

SOLES

Install a sole at each block joint and on both sides of each corner

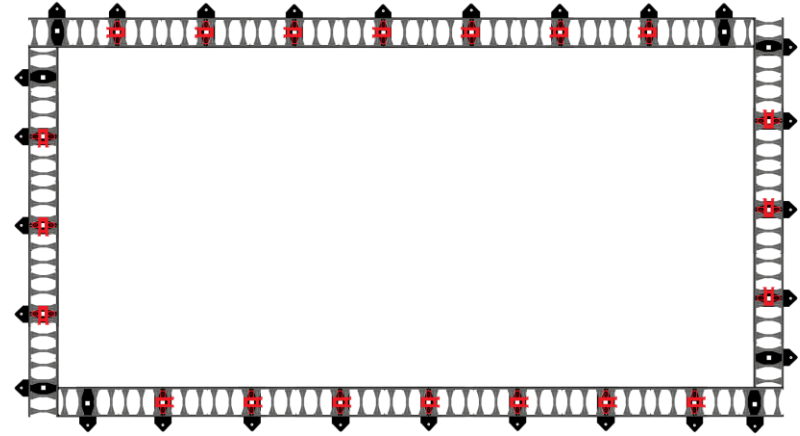

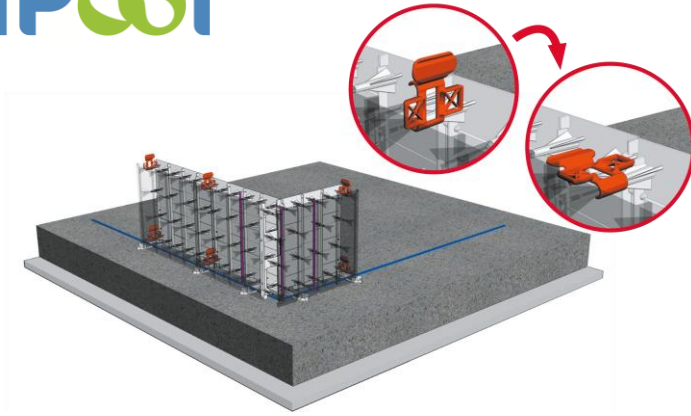

INSTALL

FIRST ROW

Install the next block with a sole following the line.

Attach each block to the next using the red *Clips*.

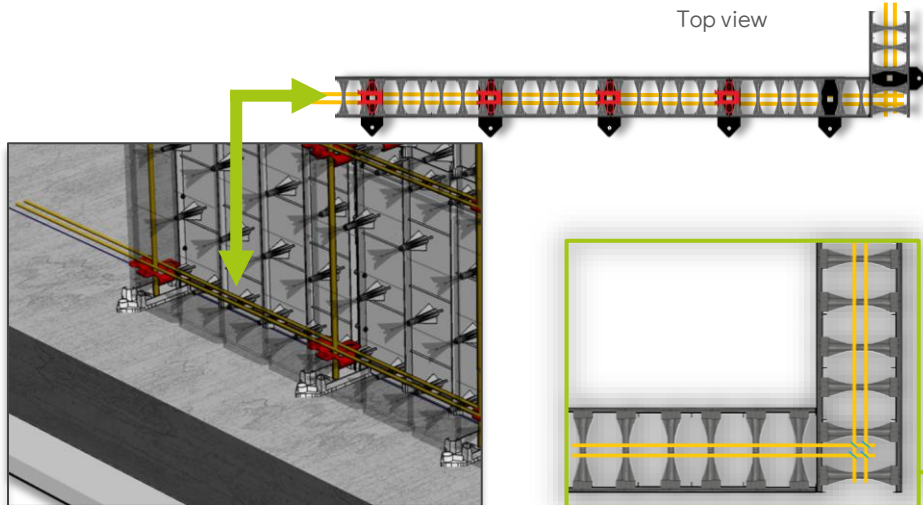

Rebar

Insert the bottom row of double rebar gradually while assembling the first row to avoid getting trapped between the structure and the excavation.

The reinforcement in the bottom corners of the wall can be crossed and fastened.

INSTALL

DEEP END

For a deep section, the blocks on the slope will have to be cut on site.

It's best to assemble the entire block row in the deep end BEFORE measuring the cuts.

The bottom slab must be installed at the correct height. The top of the blocks in the deep section must be 1" higher than the slab in the SHALLOW section.

The next row, which sits on the shallow section slab, must fit into the deep section row.

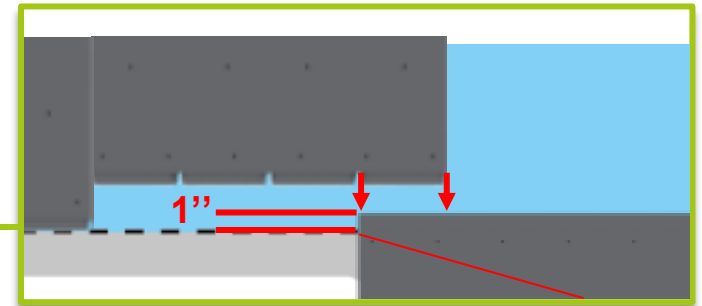
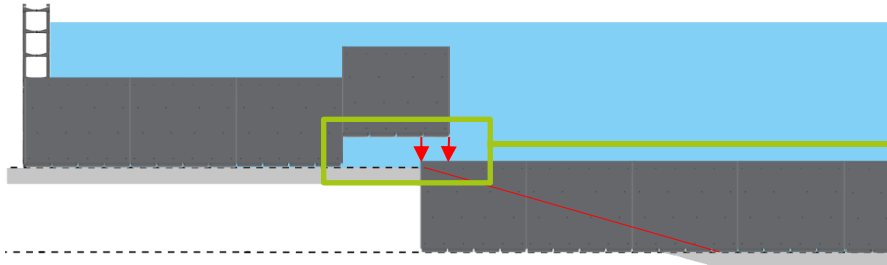
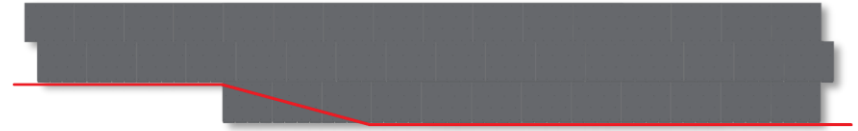
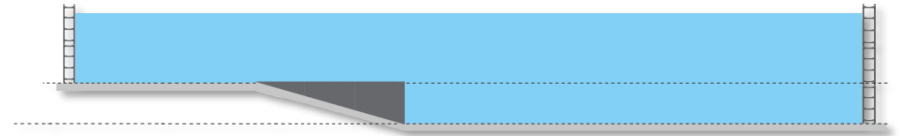

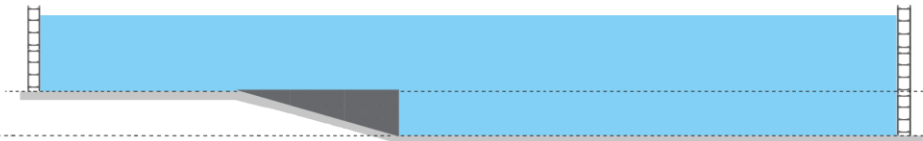
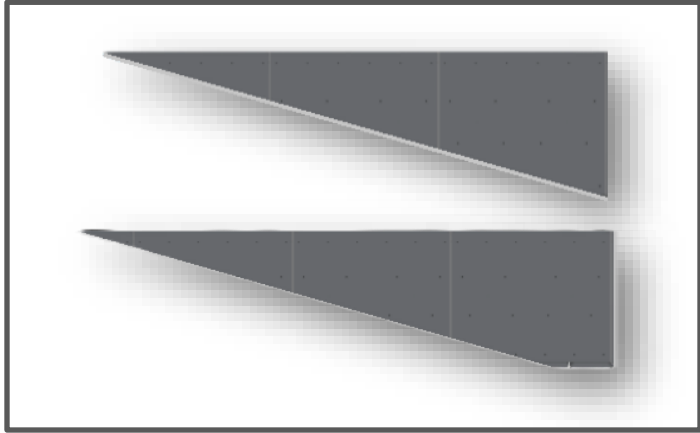
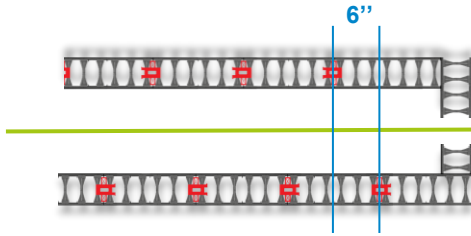

INSTALL

DEEP END

The cuts will not be the same on either side of the pool, as the blocks are staggered.

The soles cannot be installed on the cut blocks. The blocks can be secured with 2x4s fixed to the bottom of the wall.

INSTALL

COMPLETE PERIMETER

Once the first row has been installed, recheck the measurements and secure the footings to the slab.

- ❑ Check diagonals (A-C, B-D)
- ❑ Check that corners are at 90° (3,4,5 method)
- ❑ Check that walls are straight and level
- ❑ Insert concrete screws into soles to secure wall alignment.

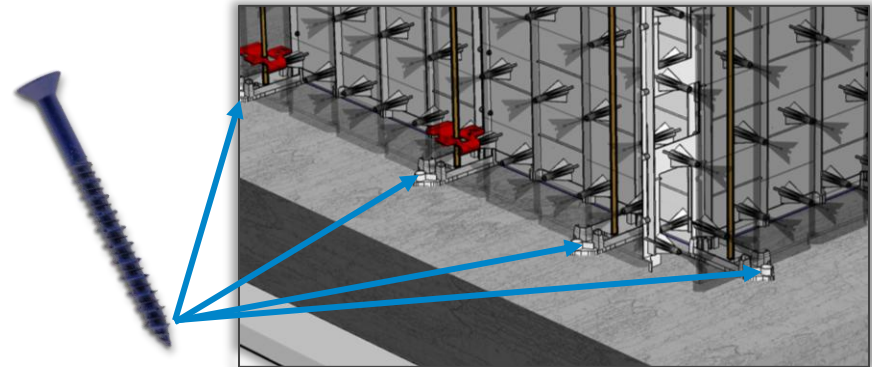
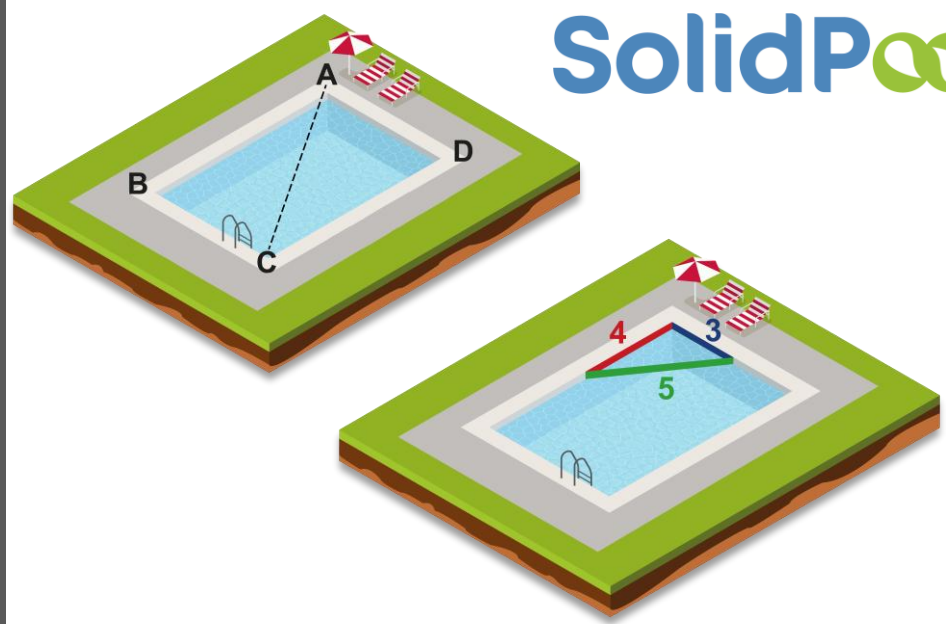

Tools

- Powerful hammer drill
- Concrete drill bit
 - Diameter : 1/2"
 - Length : 26"

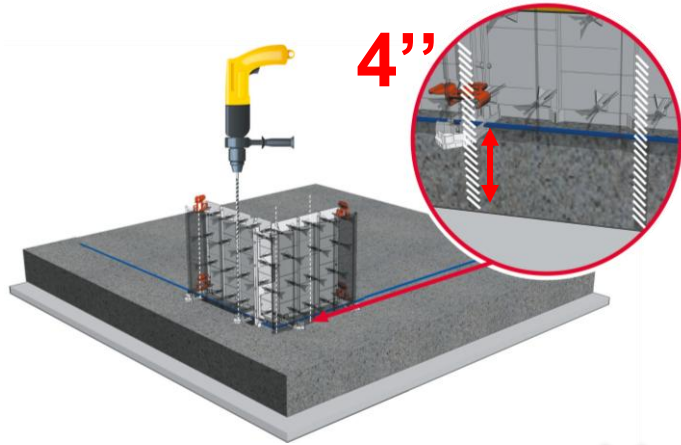

INSTALL

VERTICAL REBAR

Drill 4" deep holes in the slab to insert the vertical rebar at the spacing required for the type of structure.

The square hole in the footing serves as a guide for the rebar.

REBAR SIZING

- Diameter : 10mm
- Length : 4" longer than wall heights
- Drill bit : 1/2" diameter

REBAR SPACING

In-ground wall

- Vertical spacing : 24"
- Align with each sole

Above ground wall

- Vertical spacing : 12"
- Align with each sole + 1 rebar in the center of every block.

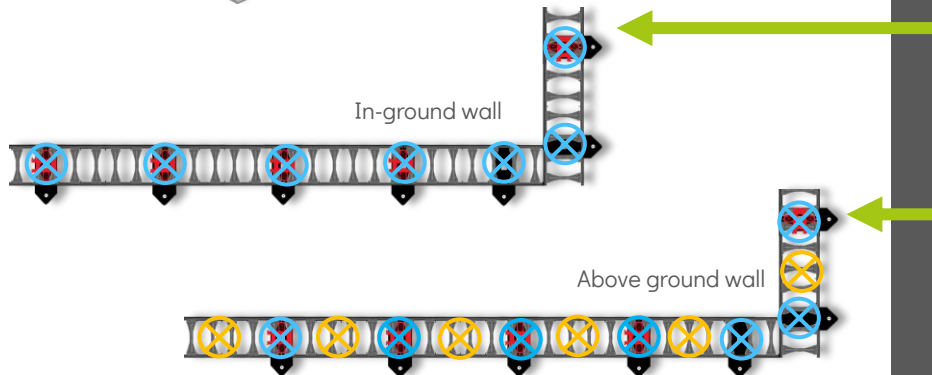

See [Technical Information](#) section for details on frame spacing.

INSTALL

VERTICAL REBAR

Use a sledgehammer to insert the reinforcing rods into the holes in the slab.

- ❑ The rebar must be long enough to reach the top of the final wall.
- ❑ If a concrete sidewalk is to be poured, the rebar can be installed longer and bent 90° to run along the sidewalk and solidify the complete structure.

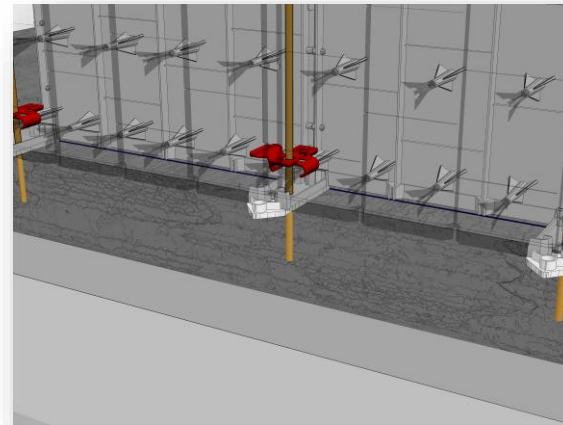
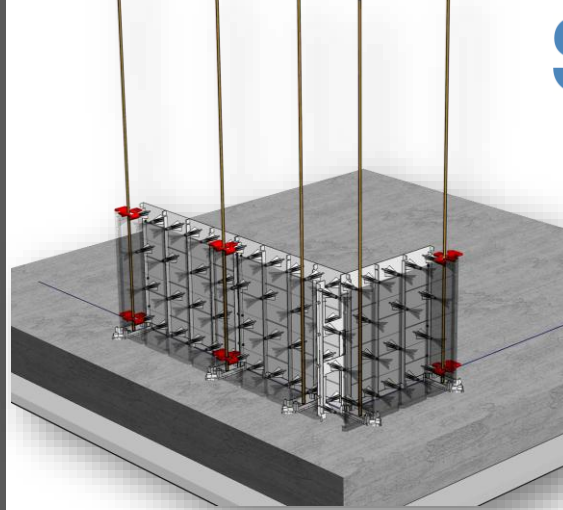



INSTALL

HORIZONTAL REBAR FOR FIRST ROW

- ❑ Place the double reinforcement on top of the first row of blocks.
- ❑ Tie stems together on either side of vertical stems and to join stem lengths to the next. Rods should extend at least 10" beyond each other.

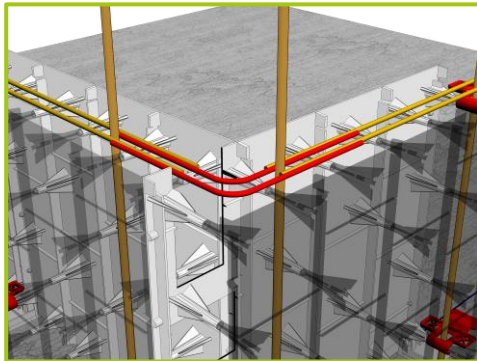

- ❑ Bend rods to make 90° corners

INSTALL

SECOND ROW OF BLOCKS

Corners

Each subsequent row of blocks is installed in the opposite direction to the previous row. This locks the corners in place and adds strength to the structure.

- ❑ The corner blocks should be prepared in the same way as the previous row.

Be careful to cut the blocks the right way, as the corners of each row are also reversed.

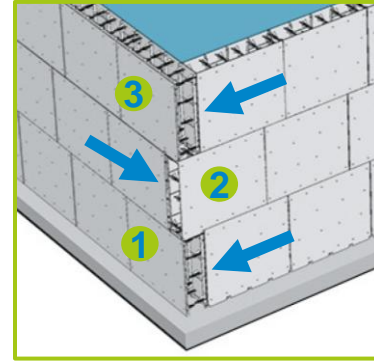

Row 1



Row 2



Row 3

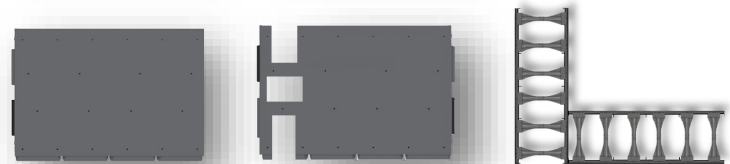

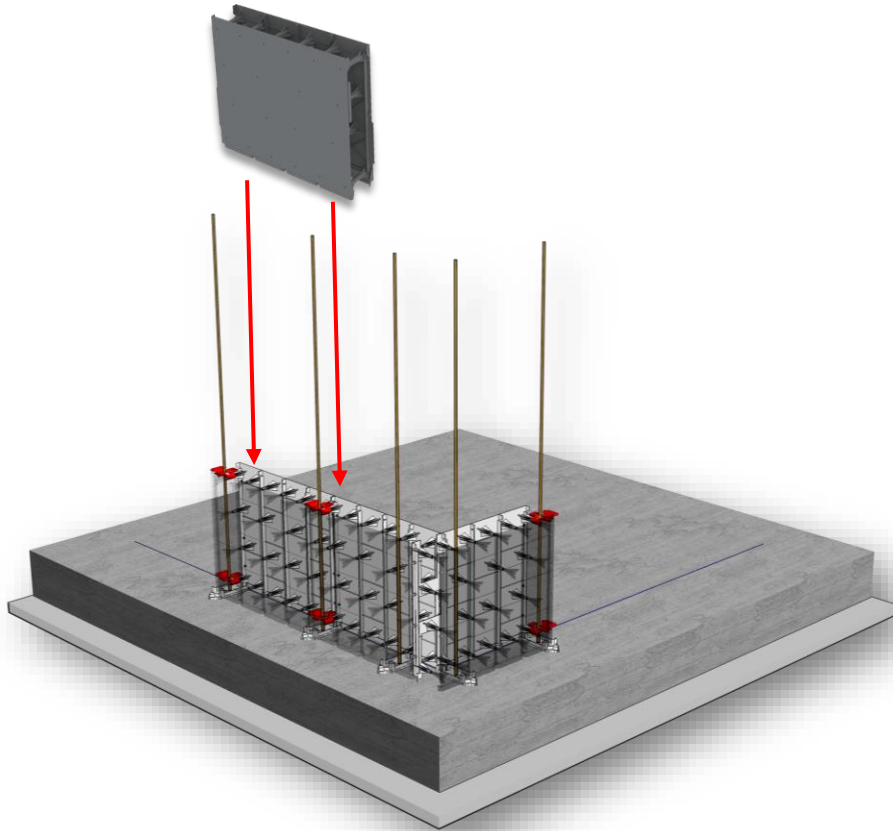

INSTALL

SECOND ROW OF BLOCKS

- ❑ Now that the vertical reinforcement has been installed, the blocks of the second row should be raised and slid over the rods.
- ❑ Install the corners and secure the blocks with the red clips.

(If the structure is to be built above ground, don't forget to insert the horizontal reinforcement in the center of the second row during installation).

If the second row is the last row, install return blocks at the desired locations (see Technical Information section for more information on return blocks).



INSTALL

REBAR FOR 2ND ROW

- ❑ Place the double reinforcement on top of the second row of blocks (if the pool has only 2 rows, install a SINGLE rod only).
- ❑ Tie stems together on either side of vertical stems and to join stem lengths to the next. Rods should extend at least 10" beyond each other.

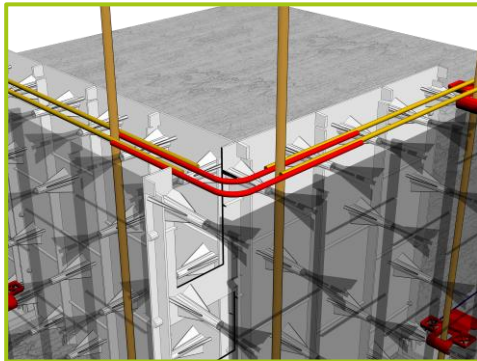

- ❑ Bend rods to make 90° corners

INSTALL

LAST ROW OF BLOCKS

Most pools will have only 3 rows of block. If the project has more than 3 rows, repeat the step from the 2nd row to the last row.

- ❑ Install return blocks where required.
- ❑ Install skimmer block(s) where required.
- ❑ Install the remaining blocks, ensuring that the corners are still reversed from the previous course (3rd course aligned with the first course).

If the structure is to be built above ground, don't forget to insert the horizontal reinforcement in the center of the last row during installation.

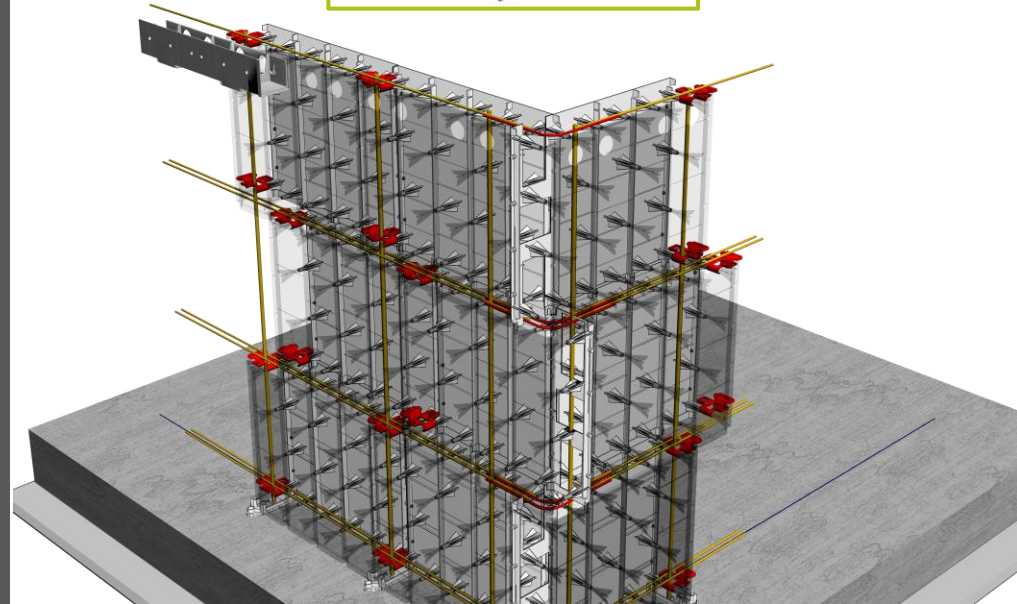
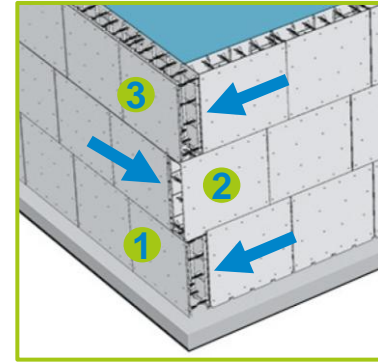

INSTALL

REBAR FOR LAST ROW

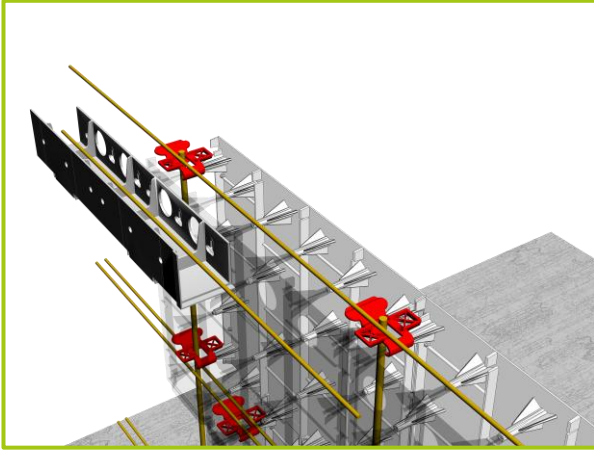

- ❑ Place the single reinforcement on top of the last row of blocks.
- ❑ Tie stems together on either side of vertical stems and to join stem lengths to the next. Rods should extend at least 10" beyond each other.

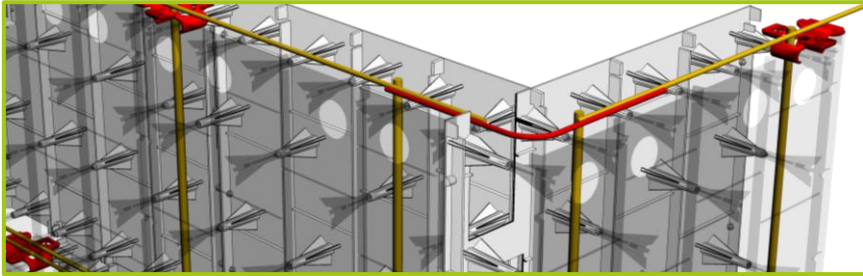

- ❑ Bend rods to make 90° corners

INSTALL

LINER RETAINER (COPING)

We recommend installing an aluminum canvas retainer that screws into the front mount.

- ❑ Screw the liner retainer to the structure using 1½" screws. Screws may be embedded in concrete.
- ❑ The liner retainer is NOT required above the skimmer. The skimmer front plate will hold the liner.
- ❑ If the structure is not perfectly level, locate the highest point of the wall, install the retainer at this level and cheat the retainer onto the lower points of the structure. (Maximum recommended adjustment: ¼")
- ❑ If a crown support is to be installed, adjust the final height of the liner retainer to be even above the support.

Front mount aluminium coping

Aluminum retainer that is fastened to the face of the wall before the concrete is poured.

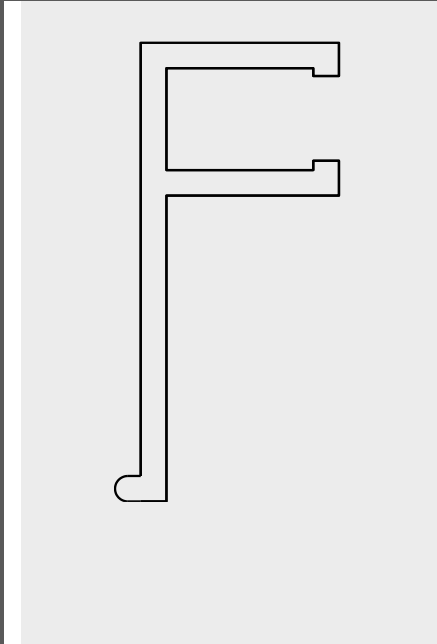

Hybrid aluminium coping

Aluminum retainer that screws into facade for installation on concrete sidewalk finished in (Bullnose)

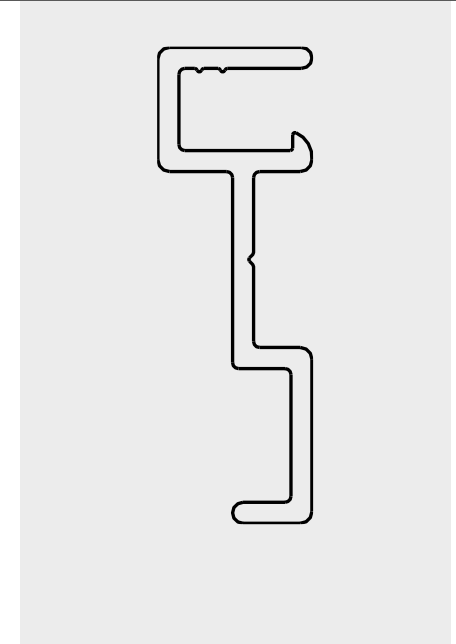

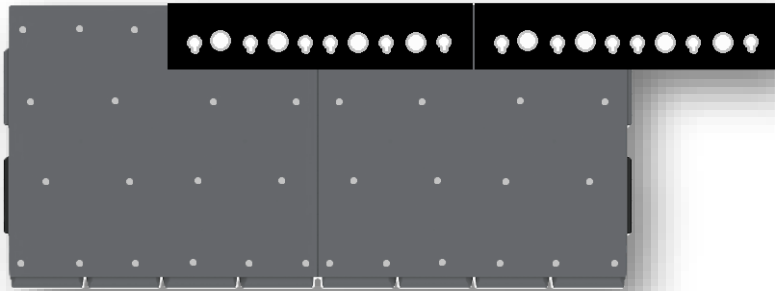
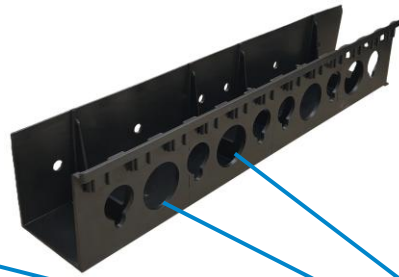

INSTALL

STONE COPING SUPPORT EXTENSION

- ❑ The coping support is clipped on the outside of the blocks
- ❑ 2" holes must be drilled on the outside of the block, in line with the large holes on the support.
- ❑ This allows the concrete to communicate between the structure and the support.
- ❑ Support pieces are the same length as a block, but are installed between 2 blocks.
- ❑ The corners must be cut at 45° to join. Single rebar should then be placed in the support before the concrete is poured.

INSTALL

INSTALLING A STEP

Steps, benches and beache entry in SolidPool blocks

- ❑ If the step or other structures to be installed are made of SolidPool blocks, these must be installed before the concrete is poured.
- ❑ However, steps, beaches or benches must NOT be backfilled before the concrete is poured. This could cause your structure to move.
- ❑ These blocks will need to be cut on site to achieve the correct width and height.
- ❑ We recommend drilling holes where the step block meets the pool wall, to allow the reinforcement AND the concrete to communicate.

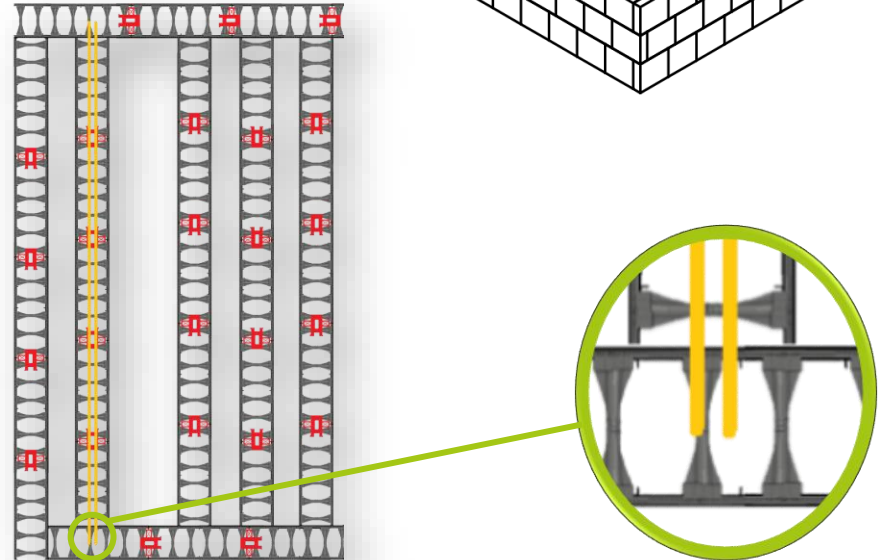
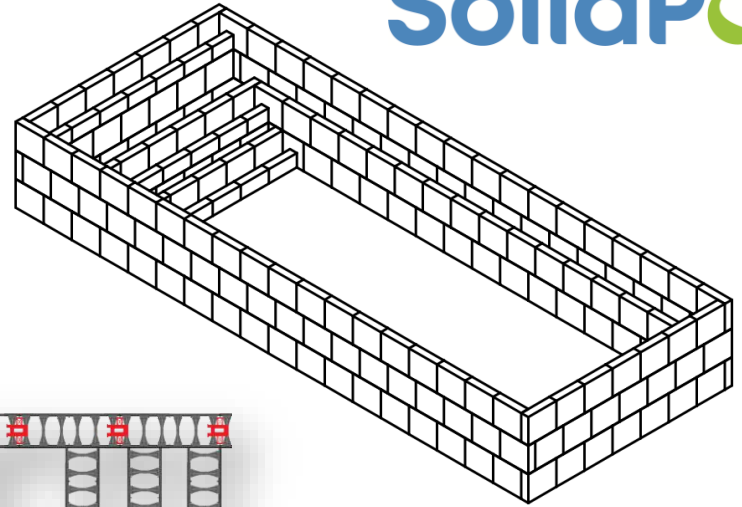

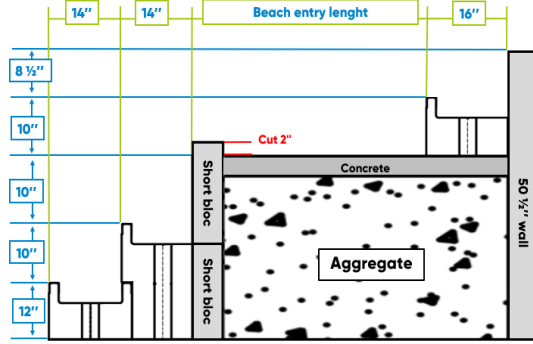
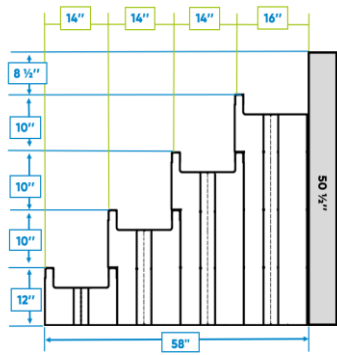

INSTALL

INSTALLING A STEP

FoamFab steps

- ❑ FoamFab steps must be installed before the concrete is poured, but since they require no backfill, they can be poured complete with the structure.
- ❑ Place the largest step in the right place.
- ❑ Install the liner retainer supplied at the back of the first step.
- ❑ Install the two smaller retainers along the sides of the step and repeat for each step.
- ❑ Place 2 rebars on each step.
- ❑ Pour concrete and screed the top.
- ❑ A combination of FoamFab steps AND SolidPool blocks may be used for steps with a deck or bench.

INSTALL

BRACE THE STRUCTURE

The structure must be secured and supported so as not to move during the concrete pour. It is the installer's responsibility to ensure that it is solid.

- ❑ We recommend the use of scaffold-supports to facilitate this process.
- ❑ The scaffold-supports are height-adjustable up to 60" high, and also serve as scaffolding during the rest of the work.
- ❑ The adjustable legs are also used to straighten and adjust the wall during pouring.





INSTALL

POURING THE CONCRETE

Concrete specs:

- ❑ 30 MPA
- ❑ Agregate : Equal or less than 3/4"
- ❑ Slump : 6 to 8 inches
- ❑ Pump mix following pump's recommendations

Important: Do not vibrate the concrete. Let the concrete run out so that the wall can fill in, and move on to the next section.

You can work the concrete in with a piece of rebar.



DO NOT VIBRATE



INSTALL

POURING THE CONCRETE

Perforated blocks

When pouring with perforated blocks, the cream of the concrete will slightly come through the blocks. The concrete can be wipe away with a trowel or a broom.

You can apply your cementitious finish immediately after pouring the walls.

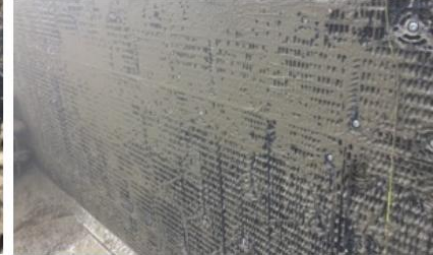

INSTALL

BACKFILL



Allow concrete to set before backfilling.

Important. Always make sure to install and secure the pool's plumbing and conduits before backfilling, to avoid damaging the plumbing or even the wall around the returns and lights.

INSTALL

LINER INSTALLATION

Underlayment

It is strongly recommended to install a pool pad underlayment on SolidPool walls and FoamFab steps before installing the liner. This protects the liner and gives a better aesthetic finish.

Skimmer

We recommend cutting the liners bead above the top of the skimmer to ensure that the skimmer front plate is screwed on tightly.



TECHNICAL
INFORMATION

SolidPool

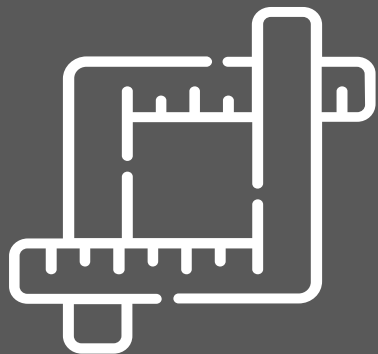

BLOCK DIMENSIONS

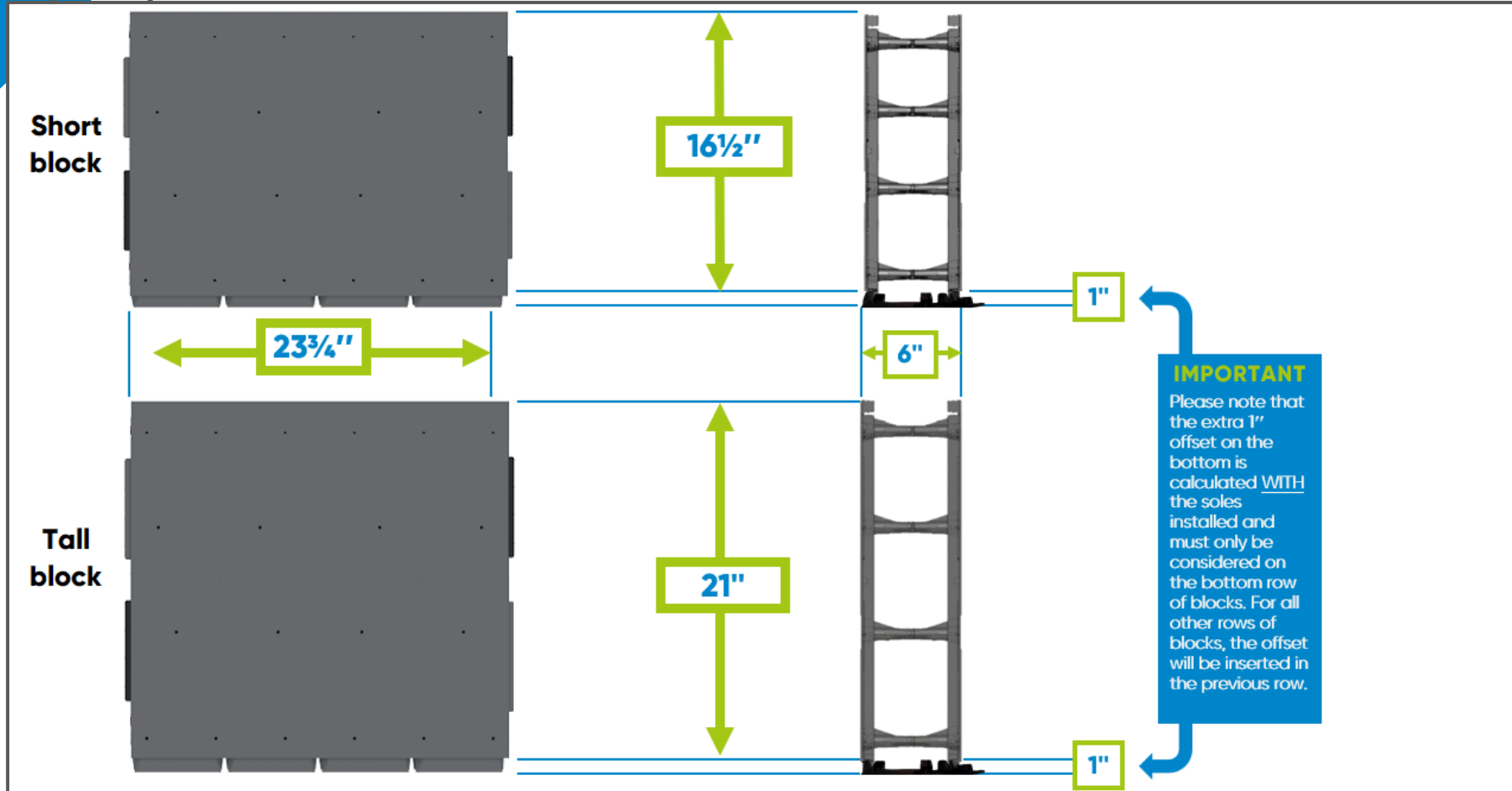



WALL HEIGHT OPTIONS

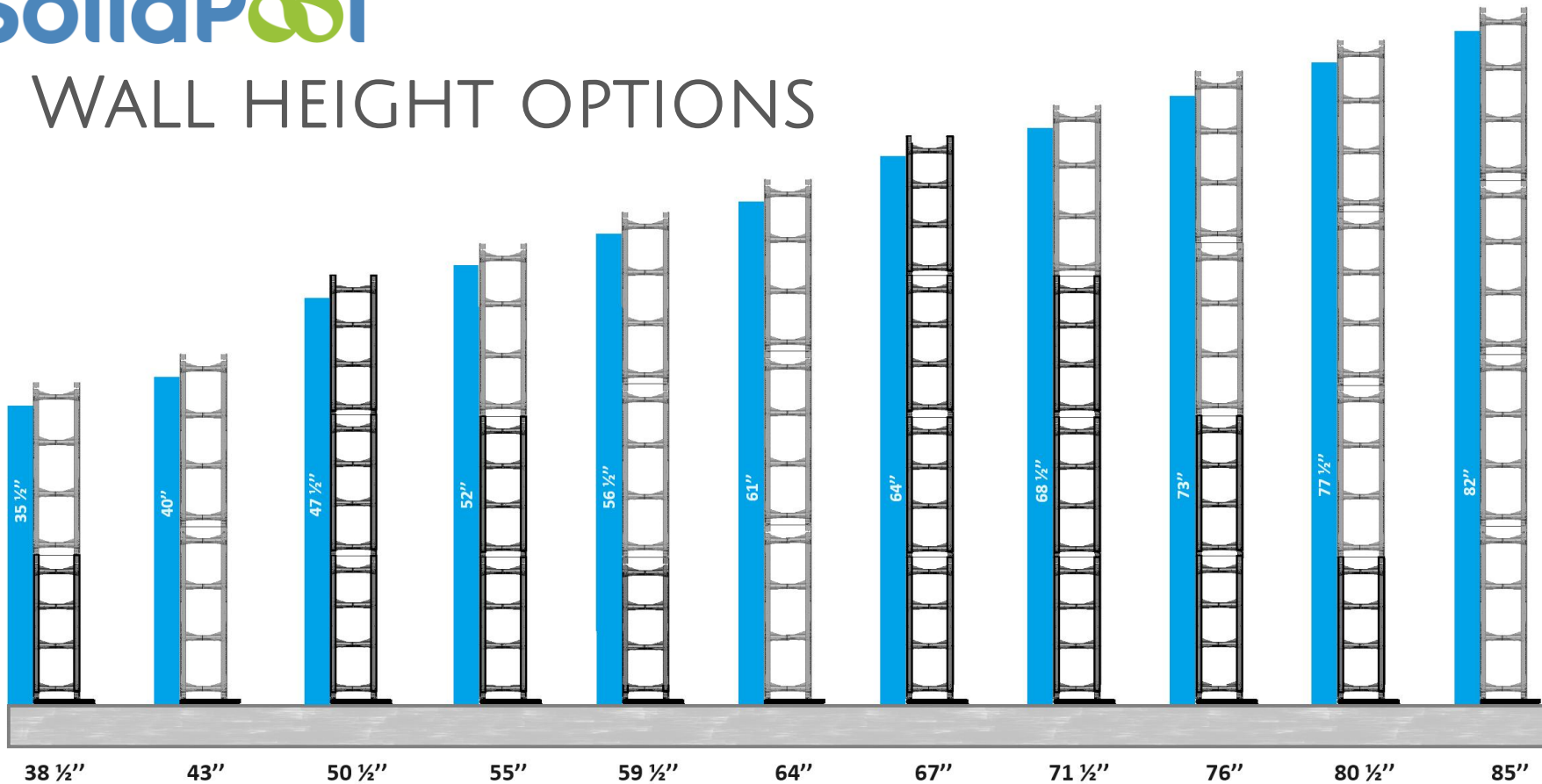

VERTICAL REBAR POSITIONING

Fully inground pool wall

Place 1 vertical rebar at every block joint on the first row and closest possible to the corner.

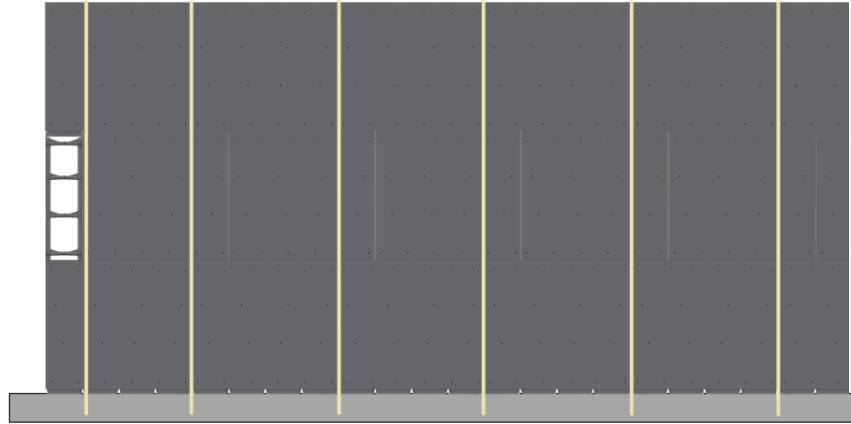

Above ground pool wall

Single vertical rod at each joint AND in the center of the blocks in the first row. Also place rebar in the corners

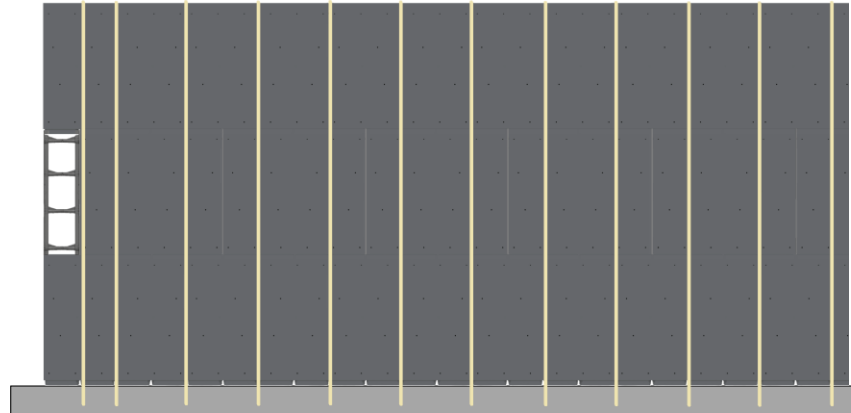

HORIZONTAL REBAR POSITIONING

Fully inground pool wall

Double horizontal rebar at the bottom of the first row.

Double horizontal rebar at the top of every row except the very top row.

Single horizontal rebar on top of last row.

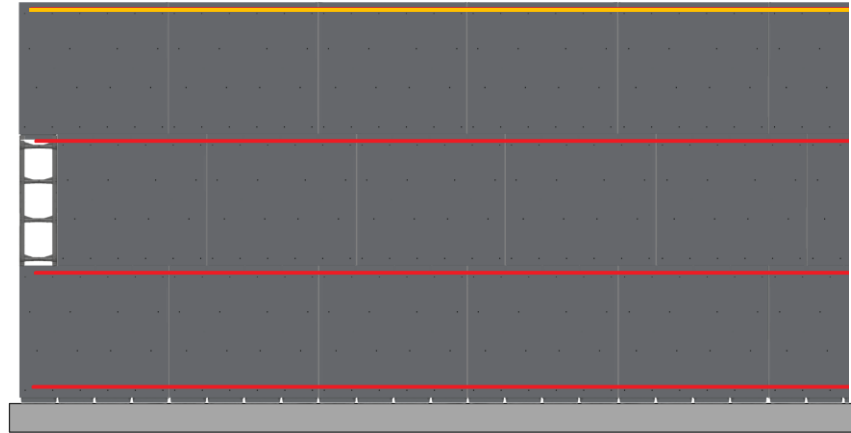

Above ground pool wall

Double horizontal rebar at the bottom of the first row.

Double horizontal rebar at the top of every row except the very top row.

Single horizontal rebar on top of last row.

Single horizontal rebar in the centre of each row of blocks.

